

Specification

Product name	Philips smart drying rack SDR603
Product model	SDR603-AA0, SDR603-AB0
Dimensions of product	2,200x588x90 mm
Dimensions of host	1,200x388x90 mm
Hole spacing of installation template	1,130x170 mm
Rod length	2,225 mm
Dropping distance	0-1,105 mm
Input voltage	220 V ~ 50 Hz
Rated power of product	116 W
Rated power of DC motor	60 W
Rated power of LED lamp	24 W
Load capacity	35 kg
Operating temperature	-15-43°C
Operating humidity	10%-90% RH, (Non-condensing)
Noise	< 55 dB
Quality standard	QB/T 5202-2017

Note: please use CTN to search the product at Philips official website.

Packing list

No.	Item	Qty	Unit	No.	Item	Qty	Unit
1	Host	1	pc	8	Rubber ring of clothes rods	1	pack
2	Scissor frame assembly	2	set	9	Set screw for scissor frame	2	pc
3	Clothes rod	2	pc	10	M8 expansion screw	4	set
4	Bed sheet rod	2	pc	11	User manual-Warranty card	1	pc
5	Remote control	1	pc	12	Quality certificate	1	pc
6	End cover	2	pc	13	Installation template	1	pc
7	Joint bar accessories	4	set				

Please check carefully after unpacking. If there is any item missing, please make timely contact with Philips or Philips authorized service center to obtain it.

Notice to users

- ◆ Ceiling for installation should be solid enough to have expansion screws firmly fixed.
- ◆ For your safety, please make sure the power supply is grounded and only use power supply indicated on this product. Do not use power supply cable smaller than 0.75 mm².
- ◆ To ensure normal operation of the product, please make sure the host is installed at places away from leaking and rain.
- ◆ Do not use the product during thunderstorms.
- ◆ Do not put hands or any other objects into scissor frame when the drying rack is running up or down.
- ◆ If batteries are not used for a long period of time, it is recommended to remove it from remote control in case of leakage and damage. Avoid using old batteries with new ones.
- ◆ For any maintenance, do not disassemble the product by yourself. Please contact Philips or Philips authorized service centers.
- ◆ If the power cord is damaged, it must be replaced by a professional from the manufacturer or its designated maintenance center.
- ◆ Power connections must be made by an electrical professional. The protection level of this product for touching energized parts is Class 1, and a leakage protection switch with large opening distance (contact opening distance of more than 3 mm) and 30 mA all-pole disconnection must be installed in the power supply line.

Product overview

- Host
- End cover of host
- Scissor frame
- Wire rope
- Rubber ring of clothes rods
- Flat head stainless steel self-tapping screws
- Whole/ retractable clothes rods
- Bed sheet rod
- Rod seat
- Joint bar
- End cover of bed sheet rod

Note
The pictures are for reference only, the actual product shall prevail.

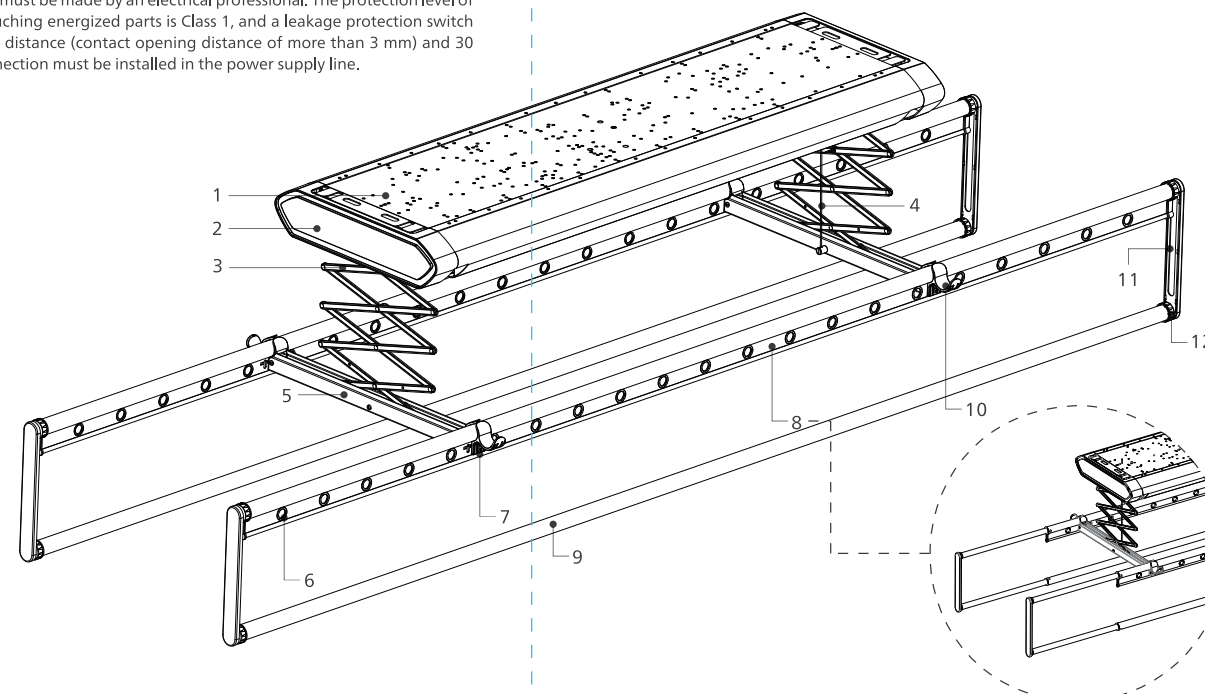

Remote control instruction

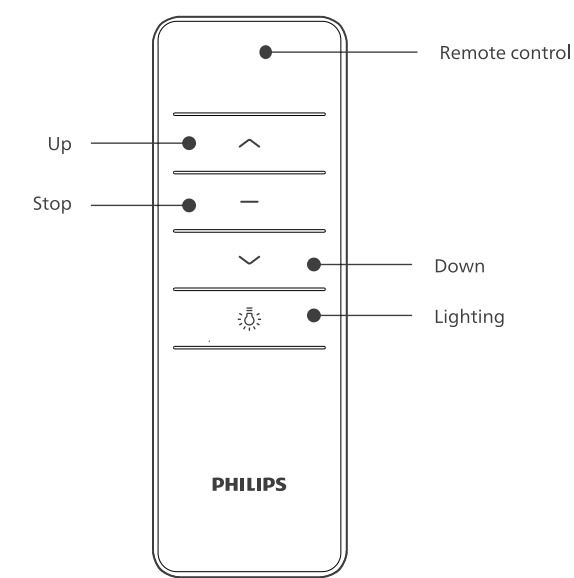

Up	Press to lift the drying rack. The rack will stop automatically at top (upper limit).
Stop	Press to stop the lifting or descending drying rack.
Down	Press to lower the drying rack. The rack will automatically stop at bottom (lower limit).
Lighting	Press to turn on LED lamp. Press again to turn it off. LED lamp will turn off automatically after 2 hours if not being turned off manually.

Kind reminder:
This user manual is used as a guide. The photos, pictures, or illustrations provided in the manual are for explanation purposes, which may differ from the specific product, please refer to the actual product. Due to product version upgrade or other needs, Philips may update this manual timely without notice. If you need the latest version of the manual, please download it from the Philips website (www.philips.com/support). The copyright of any part from this manual, including text, pictures or illustrations, belongs to Philips. Without written permission, no corporation or individual may extract, copy, translate, or modify all or part of this manual in any way. Unless otherwise agreed, Philips does not make any express or implied representations and guarantees.

Shenzhen Yunyue Intelligent Technology Co., Ltd.
Address: Room 901, Block A, Huahan Innovation Park, Nanshan District, Shenzhen, Guangdong, P.R.C.
Philips and the Philips Shield Emblem are registered trademarks of Koninklijke Philips N.V. and are used under license.

This product has been manufactured by and is sold under the responsibility of Shenzhen Yunyue Intelligent Technology Co., Ltd. and Shenzhen Yunyue Intelligent Technology Co., Ltd. is the warrantor in relation to this product.

To get product related support, please go to: www.philips.com/support.

Installation instruction

Preparation

1. Please prepare following tools before installation, including cutting pliers, hammer, Phillips screwdriver, 10-14# wrench, utility knife, tape measure, insulating gloves, insulating tape, marker, etc.
2. Choose a proper location for installing the drying rack and decide right direction.

Fix expansion screws

1. If the chosen location is installed with lamp, turn it off and remove it first.
2. Measure dimension and mark the installation location on ceiling.
3. As shown in Figure 1, paste the installation template on marked location at ceiling, then use a marker to mark out four holes.
4. As shown in Figure 2, drill 4 $\phi 10 \times 60$ mm holes, fix and tighten expansion screws with a wrench. Loosen nuts of two expansion screws at one side and keep about 5 mm distance between washer and nut. Remove nuts and washers of 2 expansion screws on the other side.



Figure 1

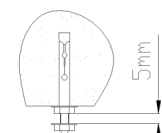

Figure 2

Install host

1. As shown in Figure 3, carefully hold the host and fix it with expansion screws and fasten nuts.
2. Connect power cables correctly. (Note: connect brown wire of host power cable to live wire, blue to neutral wire, yellow and green to grounding wire), then wrap the connected wires with insulating tape and put it in the gap between host and the ceiling.

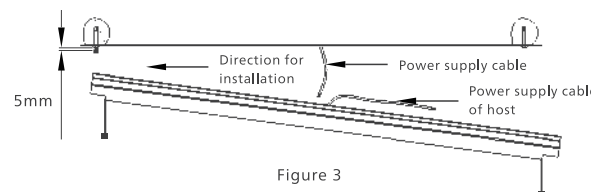

Figure 3

Install scissor frame

1. As shown in Figure 4, buckle pulley of scissor frame into the chute of mounting plate and lock it with screws.

2. As shown in Figure 5, pass the wire rope through positioning ring, then place the end part of wire rope in retainer and lock it with retainer cover.

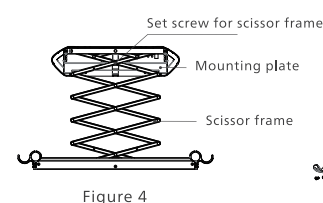

Figure 4

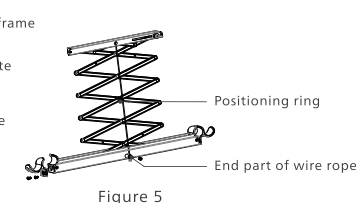

Figure 5

Install clothes rod and sheet rod

1. As shown in Figure 6, remove screws from rod seat, align the vacant position of the clothes rod with the support plate, and fix with screws.
2. As shown in Figure 7 (left is SDR603-AA0, right is SDR603-AB0), unfasten bolt from rod cover assembly and mount each part in following order, screw plug, cover of clothes rod or bed sheet rod or retractable rod, joint bar and washer. Fix all with set screw and put on cover of joint bar.

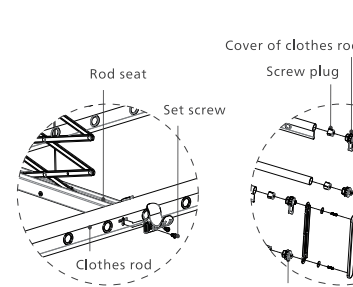

Figure 6

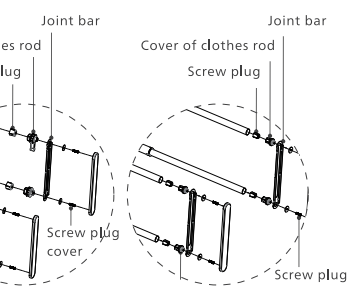

Figure 7

3. As shown in Figure 8, take bed sheet rod down when you need to dry bed sheet.
4. As shown in Figure 9, when the bed sheet rod is not needed, it can be folded and put back to rod seat.

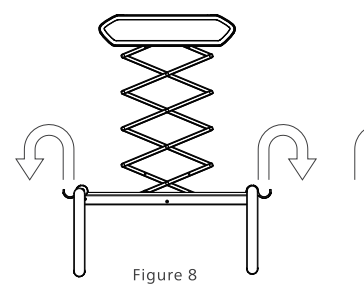

Figure 8

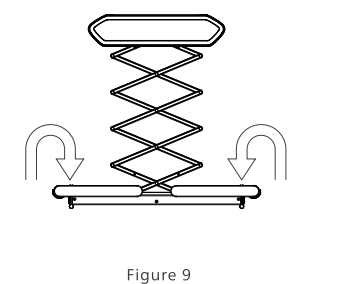

Figure 9

Remote control programming instruction

- ◆ Program the remote control before use it.
- ◆ Programming: unplug host power and replug it after 10 seconds, after which the buzzer will have a long beep. Following the beep, press "Up" and "Down" at the same time and the buzzer will beep for 3 times, indicating successful programming.

Function test instruction

- ◆ Down: press "Down" and check whether the drying rack can automatically stop running after it drops about 1.1 m.
- ◆ Up: press "Up" and check whether the drying rack can automatically stop running after it reaches to the top.
- ◆ Lighting: press "Lighting" and check whether the LED lamp can be turned on and off normally.
- ◆ Push to lift: push rod or rod seat of the drying rack with your hand, then let go and check whether the drying rack will automatically rise.
- ◆ Hold to stop: when the drying rack is dropping, hold up the rod or rod seat of the drying rack to check whether it stops immediately.

Troubleshooting

Failure	Possible reasons	How to solve
Remote control does not work	The host is not powered; low battery power; remote control is not programmed.	Power on host; replace batteries of remote control; re-program remote control
Drying rack stops suddenly during running	Drying rack encounters resistance and triggers switch; motor's self-protection from overheating.	Remove objects causing resistance; wait for motor to cool down before start it again
LED lamp doesn't work	The host is not powered; LED lamp is damaged.	Power up the host; replace LED lamp.

Warranty card

Relevant information			
User name	Contact of user		
Address of user			
Product name	Model of product		
Serial number	Invoice No.		
Seller name	Date of sales		
Seller address			
Maintenance records			
Date	Issue	Maintenance staff	User signature

PHILIPS

6000 Series

Smart drying rack

SDR603



User manual

Please read this user manual carefully before using this product. Thank you for purchasing Philips-branded products. For your safety, please read this user manual carefully before using the product. Any personal injury, property or other loss caused by not following the user manual or precautions, no liability will be assumed by Philips.

PHILIPS		比例	1:1
		尺寸	100*200mm (成型)
名称	飞利浦智能晾衣架SDR603 用户手册	颜色	黑色 (COMOYOK90)
		材料	105g双铜纸
日期	2023. 7. 31	设计	冯泽丹